

# Rumney Models Price List – September 2018

www.rumneymodels.co.uk  
Rumney Models, 3 Warren Terrace, Trellech, Monmouthshire, NP25 4PH  
justinnewitt@gmail.com  
07798 627143  
01600 860472

This list replaces all previous lists.  
Items are 4mm scale and are suitable for OO/EM & P4 except where noted.

## New Items

### 4mm Scale

**B.75** 1927 RCH oil tank underframe - 10' wheelbase

**B.76** 1927 RCH oil tank underframe - 9' wheelbase

**B.113** Bachmann cradle mounted tank wagon detailing

**G.01** BR 5'6" Plate freight bogie - Oil journals

**G.02** BR 5'6" Plate freight bogie - Roller bearing journals

### Various Wagon axlebox and spring castings

5 leaf springs with LMS sloping Platefront axleboxes

6 leaf springs with RCH, LMS and LNER axleboxes

GWR brake van springs (later type) with RCH and BR axleboxes (10" journals)

LMS Stanier brake van

### Change in status on some items

With the last price list (June 2018) there was a change in status for some items. A few were withdrawn and some others are now available only in a minimum quantity, the later feature in my separate special order list. All are marked in this price list.

United Dairies milk tank plates are now back in stock in both 4mm and 7mm scales as are many of the castings I ran out of recently.

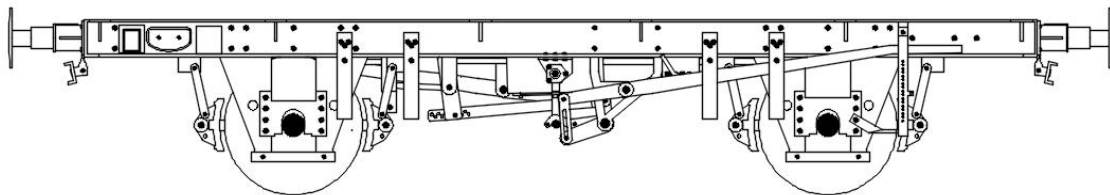

## Index

Milk tank chassis and detailing components	Pages 2 & 3
Wagon underframes	Pages 4 to 6
Wagon detailing	Page 6 & 7
Wagon kits	Pages 7 to 9
Wagon Castings	Pages 9 to 12
Sprung freight bogies	Page 12 & 13
Sprung diesel bogies	Page 13
Sprung coach bogies	Page 13
Steam Loco chassis	Page 14
Miscellaneous items	Page 14
7mm scale items	Page 14 & 15
S scale items	Page 16

## 4mm Scale

### Sprung Milk Tank Chassis and Detailing Parts

Designed for use with the David Geen milk tank kits. Etch and spring wire (where appropriate) only.

#### Milk Tanks Chassis

Code	Description	Price per unit
A.01	GWR Standard Milk Tank Chassis <i>20'6" long for the majority of GWR milk tanks.</i>	£11
<b>A.02</b>	GWR Long Milk Tank Chassis <i>A longer 21'6" chassis for twin tank vehicles.</i>	Withdrawn
A.03	LMS Early Milk Tank Chassis <i>For LMS milk tanks built before around 1942.</i>	£11
A.04	LMS Late Milk Tank Chassis <i>For LMS milk tanks built after around 1942.</i>	£11

#### Detailing Parts

A.07	United Dairies SR/GWR Platforms <i>The distinctive platforms fitted to some United Dairies milk tanks.</i>	£7
A.08	SR/GWR Platform construction jig <i>Needed to build A.07.</i>	£5
A.09	GWR Detailing <i>GWR lever brakegear, brake shoes/yolks, tiebars and ladders.</i>	£7
A.10	GWR Alternative Ladders and Walkways <i>Partial platforms, long ladders and planked type walkways.</i>	£7
A.11	LMS Detailing <i>Brake shoes/yolks, tiebars and alternative ladders.</i>	£7
A.12	Milk Tank Formers <i>For constructing different diameter tanks from brass sheet.</i>	£6

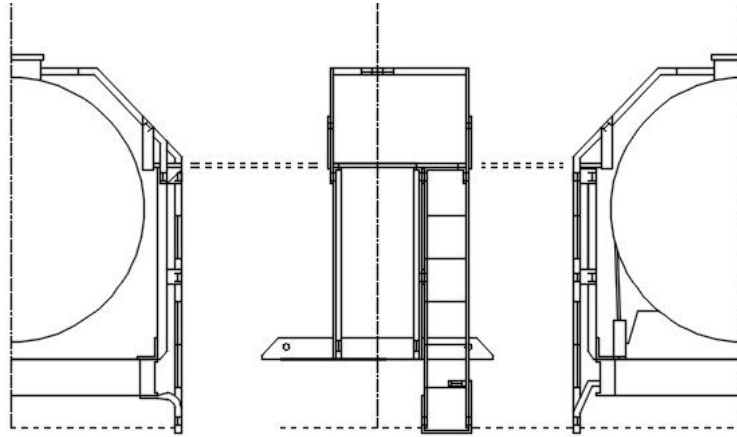

### Milk Tank Plates

Code	Description	Price per unit
A.21A	United Dairies Ltd Milk Tank Plates - Type A <i>Company plates for United Dairies milk tanks.</i>	£2.50
A.21B	United Dairies Ltd Milk Tank Plates - Type B <i>Company plates for United Dairies milk tanks.</i>	£2.50
A.22	Unigate Creameries Milk Tank Plates <i>Company/number plates for Unigate milk tanks.</i>	£2.50
A.23	Express Dairy Milk Tank Plates <i>Company/number plates for Express Dairy milk tanks.</i>	£2.50



- United Dairies Type A



- United Dairies Type B



- Unigate Creameries



- Express Dairy

The United Dairies plates were common in the 1950s but could also be seen through to the 1970s. Type A was much more common than type B. Unigate plates would be found on wagons post 1959. The Unigate plates have the wagon number on the plate. I have done plates for most Unigate diagrams. Please enquire first if you are after plates for specific diagrams. If you aren't worried about diagrams then please say so when ordering. Express Dairy plates include both the company plate and the distinctive round number plate that was attached to the baulks at the tank ends. The numbers were Express Dairy's own fleet numbers and were generally grouped according to who built the milk tank. If you want something specific then please inquire or else you will get a random number. Etched on 0.1mm stainless steel and supplied in pairs and painted.

## Sprung Wagon Chassis

These are comprehensive and include solebars and headstocks. They are designed for use with Parkside Dundas, Red Panda and, in the case of B.06, Chivers Finelines plastic body kits. Etch and spring wire only. The following notation for axleguard types is used:

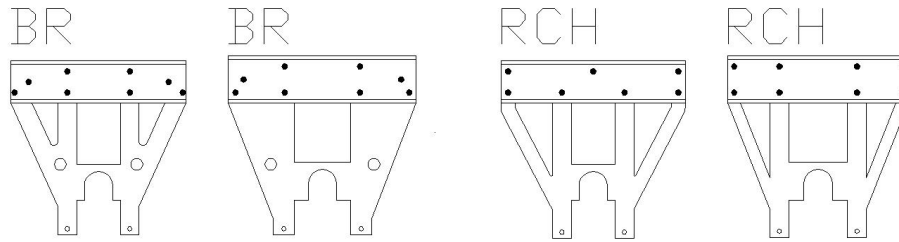

### BR Clasp Brake

Code	Description	Price per unit
B.01	BR 17'6" x 10' BR Clasp Brake Chassis <i>For BR standard vans, Conflats, Shocvans, Shocopens, Lowfits, etc.</i>	£10
<b>B.02</b>	BR 16'6" x 10' BR Clasp Brake Chassis – 26T Iron Ore Tippler <i>For diagram 1/165 iron ore tipplers.</i>	Special Order List
<b>B.03</b>	BR 16'6" x 10' BR Clasp Brake Chassis – 13T Sand Tippler <i>For diagram 1/073 sand tipplers.</i>	Special Order List
B.04	BR 16'6" x 9' BR Clasp Brake Chassis – 16T Welded Mineral <i>For clasp braked diagram 1/108, 1/114 and 1/117 minerals.</i>	£10
<b>B.05</b>	Additional Parts for Riveted 16T Clasp Braked Minerals <i>For use with B.04 to produce a chassis for the rare clasp braked 1/109s.</i>	Withdrawn
<b>B.06</b>	BR 21'6" x 12' BR Clasp Brake Chassis – 21T Mineral <i>For diagram 1/119 'MDVs' (twin vacuum cylinders/changeover levers)</i>	Special Order List
B.08	BR 27' x 15' BR Clasp Brake Chassis – 22T Plate (new builds) <i>For diagram 1/434 Plate wagons built new with the BR clasp brake.</i>	£15
B.09	BR 27' x 15' BR Clasp Brake Chassis – 22T Plate (retrofits) <i>For diagram 1/430 and 1/431 Plate wagons retrofitted with the BR clasp brake in the late 50s/early 60s.</i>	£15

### Morton/Lifting Link Pushrod Brakegear

B.11	BR 17'6" x 10' Morton Brake Chassis <i>For BR standard vans, Conflats, Shocvans, Shocopens, opens, etc.</i>	£10
B.12	RCH 17'6" x 10' Morton Brake Chassis <i>For vans, Conflats, Shocvans, Shocopens, opens, etc.</i>	£10
B.13	BR 16'6" x 9' Morton Brake Chassis – 16T Welded Mineral <i>For the standard welded body, Morton braked 16T mineral wagons.</i>	£8
B.14	Additional Vacuum Braked 16T Mineral Parts <i>Use with B.13 to produce the mid-sixties Morton 4 shoe vacuum braked 16T welded minerals – sufficient for 2 wagons.</i>	£3.50
B.15	BR 16'6" x 9' Morton Brake Chassis – 16T Riveted Mineral <i>For diagram 1/109 riveted 16T minerals.</i>	£8
B.16	BR 16'6" x 9' Independent Brake Chassis – 16T Welded Mineral <i>For early 16T welded minerals, covers the following diagrams: 1/102 (with BR W-Irons), 1/104, 1/106, 1/108 and 1/111.</i>	£9
<b>B.17</b>	BR 16'6" x 9' Independent Brake Chassis – 16T Riveted Mineral <i>For diagram 1/103 (with BR W-Irons) and 1/105 16T minerals.</i>	Special Order List

Code	Description	Price per unit
B.18	Additional RCH W-Iron Parts for Independent Brake Minerals <i>Use with B.16 or B.17 to produce the earlier RCH W-Iron fitted LMS and LNER minerals. Intended for use with modified Parkside bodies.</i>	£3.50
B.21	BR 21'6" x 12' Lifting Link Brake Chassis – Welded Minerals <i>For diagram 1/107 21T &amp; diagram 1/115 &amp; 1/118 24½T minerals.</i>	£11
B.22	BR 21'6" x 12' Lifting Link Brake Chassis – 21T Riveted Minerals <i>For diagram 1/110 minerals.</i>	£11
B.23	RCH 21'6" x 12' Lifting Link Brake Chassis <i>For pre-Nationalisation 20/21T minerals.</i>	£11
<b>B.24</b>	BR 16'6" x 10' Independent Brake Chassis – 27T Iron Ore <i>For diagram 1/184 iron ore tipplers.</i>	Special Order List
<b>B.25</b>	BR 16'6" x 9' Independent Brake Chassis – 27T Iron Ore <i>For diagram 1/181, 1/182 &amp; 1/183 iron ore tipplers.</i>	Special Order List
<b>B.26</b>	BR 16'6" x 9' Morton Brake Chassis – 13T Sand Tippler <i>For diagram 1/071 &amp; 1/072 sand tipplers.</i>	Special Order List
B.27	27' x 15' Lifting Link Brake Chassis – 22T Plate <i>For LMS, LNER and BR unfitted Plate wagons. Note that the kit contains both RCH and BR type axleguards.</i>	£15
B.28	BR 21'6" x 12' Lifting Link Brake Chassis – 21T Hopper <i>For diagram 1/146 21T coal hoppers. Includes parts for both fitted and unfitted wagons.</i>	£13
<b>B.29</b>	RCH 21'6" x 12' Morton Brake Chassis – 21T Hopper <i>For mainly private owner 21T coal hoppers.</i>	Special Order List
B.30	BR 16' x 9' Morton Brake Chassis - 13T China Clay Open <i>For BR diagram 1/051 china clay opens. Designed for the Ratio kit but can be used with the Bachmann model.</i>	£10
B.32	RCH 17'6" x 9' Morton Brake Chassis <i>For LMS &amp; GWR vans, Conflats, opens, etc.</i>	£11
B.34	BR 21'6" x 12' Lifting Link Brake Chassis – BR Grampus <i>For unfitted Grampus. Underframe and body detailing. Includes the distinctive baskets used to hold the removable ends.</i>	£15
B.35	RCH 21'6" x 12' Lifting Link Brake Chassis - GWR & SR Tunny <i>For use with the Chivers GWR and SR Tunny kits.</i>	£13.50

#### LMS/Derby/LNER Clasp Brake

B.51	BR 17'6" x 10' LMS Clasp Brake Chassis <i>For Vans, Opens, Shocopens, Conflats, etc</i>	£12
B.52	RCH 17'6" x 10' LMS Clasp Brake Chassis <i>For Vans, Opens, Conflats, etc</i>	£12
B.53	BR 17'6" x 10' Derby Clasp Brake Chassis <i>For lot 3082 and 3232 Shocopens and the Vanwides</i>	£12
B.54	BR 32' x 18'6" BR Clasp Brake Tube Chassis <i>For clasp brake diagram 1/448 Tubes</i>	£15
B.61	BR 17'6" x 10' LNER Clasp Brake Chassis <i>For Vans, Shocvans, Opens, Lowfits, etc</i>	£11

## Tank Wagon Underframes

Code	Description	Price per unit
B.71	BR 17'6" x 10' Independent Brake Chassis - 14T Anchor Tanks <i>For the Bachmann anchor mount tank wagon. Includes ladders and valve wheel for detailing the body.</i>	£15
B.72	Additional Parts for 14T Anchor Mount Chassis - RCH axleguards <i>Replacement parts for B.71 for early 14T wagons - Requires B.71</i>	£2.50
B.73	Additional Parts for 20T Anchor Mount Chassis - BR Plate axleguards <i>Replacement parts for B.71 for later 20T wagons - Requires B.71</i>	£2.50
B.74	Additional Parts for 20T Anchor Mount Chassis - BR Plate axleguards <i>Replacement parts for B.71 for early 20T wagons - Requires B.71</i>	£2.50
<b>B.75</b>	RCH 17'6" x 10' Independent Brake Chassis (1927 underframe) For saddle and cradle mounted tank wagons built after 1927. Can be used with the Bachmann cradle mounted tank wagon.	£14
<b>B.76</b>	RCH 17'6" x 9' Independent brake Chassis (1927 underframe) For saddle and cradle mounted tank wagons built shortly after 1927 (9' wheelbase wagons were generally only built for a few years after 1927). Can be used with the Bachmann cradle mounted tank wagon.	£14

## Wagon Detailing Parts

Additional components for use with Rumney Models wagon chassis

B.91	Brackets and Covers for Shock Absorbing Wagons <i>Provides brackets and covers for the distinctive shock absorbing gear used on opens and vans. GWR and LMS/BR variations are covered. Requires 8BA or M2 bolt thread for the springs.</i>	£2.50
B.92	Tarpaulin Bar Detailing <i>For BR/LMS open wagons with corrugated steel ends. Both early and late types are included. Sufficient parts for two wagons. Wire for the bar is required.</i>	£3
B.93A	Buffer springing mechanism - 9" solebar <i>Provides guitar wire leaf springing for buffers. Suitable for Rumney Models underframes with 9" solebars. Sufficient for 6 wagons and includes parts for shock absorbing wagons.</i>	£4.50
B.93B	Buffer springing mechanism - 10" solebar <i>Provides guitar wire leaf springing for buffers. Suitable for Rumney Models underframes with 10" solebars. Sufficient for 5 wagons.</i>	£3
B.94	Wagon Coupling hooks <i>Sufficient for 7 wagons.</i>	£1.50
B.95A	BR Instanter links <i>Sufficient for 7 wagons.</i>	£1
B.96	Screw couplings <i>Sufficient for 2 wagons.</i>	£1.50
<b>B.101</b>	LNER/BR Steel Open Detailing <i>Etched end stanchions to replace those on the end of Parkside bodies. Two profiles covering LNER and BR builds. Label boards and LNE style lamp irons also included. Sufficient parts for 3 wagons.</i>	Withdrawn
<b>B.102</b>	LMS Corrugated Steel Ended Wooden Open Detailing <i>Body side capping and strapping, lamp irons and label boards.</i>	Withdrawn

Code	Description	Price per unit
<b>B.103</b>	BR Corrugated Steel Ended Wooden Open Detailing <i>Body side capping, lamp irons and label boards.</i>	Withdrawn
<b>B.104</b>	BR Corrugated Steel Ended Wooden Shocopen Detailing <i>Body side capping and strapping, lamp irons, label boards and cleats as well as the body side part of the corrugated end.</i>	Withdrawn
<b>B.105</b>	Ratio LMS Van Detailing <i>Diagonal side strapping as fitted in BR days, lamp irons, label boards.</i>	Withdrawn
B.106	Bachmann Anchor Mount Tank Wagon Detailing <i>Two sets of different ladders, brake levers, brake lever guards, tie bars and valve wheel. Sufficient parts for 2 wagons.</i>	£4
B.107	BR 13T China Clay Open Detailing Etched end stanchions to replace those on the end of Ratio bodies. Lamp irons also included. Sufficient parts for 6 wagons.	£3
B.108	General Wagon Detailing Lots of little bit for detailing up plastic kits and RTR models. Includes solebar detailing (number plates, label clips, etc), label boards and lamp irons. Sufficient bits for 3 or 4 wagons.	£3
B.109	BR Grampus detailing A pair of baskets, door springs and end steps for detailing the Parkside kit.	£3.50
B.112	Backing Plates for Heavy Duty Axleboxes For use with Rumney Models HD axlebox and spring castings when fitting to other manufacturer's underframes. Sufficient for three wagons.	£0.50
<b>B.113</b>	Bachmann Saddle Mounted Tank Wagon Detailing Two sets of different ladders, brake levers, brake lever guards, tie bars, valve wheel, tank straps and outside solebar crosshead tie down brackets. Sufficient parts for 2 wagons.	£4.50

### Wagon Kits

Wagon kits are generally etch only except where noted. No bogies or castings are included. Bogies for some of these wagons are now available. See below.

### Bogie Steel Wagons

C.01	BR 42T Strip Coil Wagon <i>Diagram 1/403 and 1/407 steel coil wagons. Covers the South Wales Strip Coils from 1955 onwards.</i>	£24
C.02	BR 42T Strip Coil Wagon - Wood Lined <i>Diagram 1/401 steel coil wagons. Covers the South Wales Strip Coils up to 1955.</i>	£24
C.04	BR 32T Bogie Bolster E Detailing (includes brass angle for trussing) <i>An "upgrade" etch for the Lima Bogie Bolster E model. Includes full brakegear, etched 'queen posts', trussing jigs and solebar/headstock detailing. <b>No longer includes brass angle for the trussing.</b></i>	£4.50
C.04A	BR 32T Bogie Bolster E Underframe <i>For use with C.04 to produce a fully etched chassis. Includes solebars, headstocks and detailing.</i>	£5.50

Code	Description	Price per unit
C.05	BR Bogie Bolster C/GWR Macaw B Detailing (includes brass angle for trussing) <i>An "upgrade" etch for the Bachmann/Mainline BBC/Macaw B model. Includes full brakegear (with options for GWR D/C, unfitted lever brake and fitted lever brake types), etched 'queen posts' and trussing jigs and solebar/headstock detailing. <b>No longer includes brass angle for the trussing.</b></i>	£10.50
C.05A	BR Bogie Bolster C/GWR Macaw B Levers & Vees - Lever Brakegear <i>Proper lever brakegear and detailing parts for the Bachmann/Mainline BBC/Macaw B models. This etch does not include anything to replace the trussing on the model. Includes sufficient parts for 2 wagons with options for either 1 x fitted and 1 x unfitted or 2 x unfitted wagons.</i>	£9
C.05B	BR Bogie Bolster C/GWR Macaw B Levers & Vees - D/C Brakegear <i>Proper D/C brakegear and detailing parts for the Bachmann/Mainline Macaw B models. This etch does not include anything to replace the trussing on the model. Includes sufficient parts for 2 wagons.</i>	£6

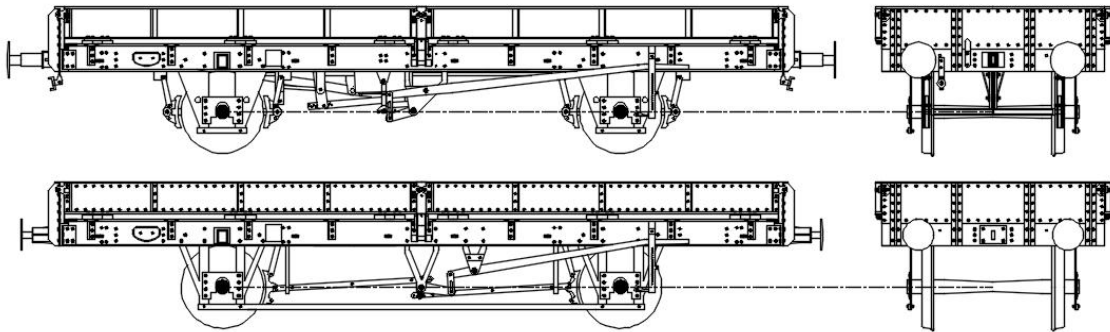

#### 4 Wheel Steel Wagons

C.21A	22T Plate Wagon with Welded Body – BR Clasp Brake Chassis (new builds) <i>BR diagram 1/434 Plate wagons built new with the BR clasp brake. Body and chassis kit B.08.</i>	£27
C.21B	22T Plate Wagon with Welded Sides and Riveted Ends – BR Clasp Brake Chassis (retrofits) <i>BR diagram 1/430 and 1/431 Plate wagons retrofitted with the BR clasp brake in the late 50s/early 60s. Body and chassis kit B.09.</i>	£27
C.21C	22T Plate Wagon with Welded Sides – Lifting Link Brake Chassis <i>LMS, LNER and BR unfitted Plate wagons with welded sides. Includes both welded and riveted ends. Body and chassis kit B.27.</i>	£27
C.22	22T Plate Wagon with Riveted Body – Lifting Link Brake Chassis <i>LMS &amp; LNER unfitted Plate wagons with fully riveted bodies. Body and chassis kit B.27.</i>	£27



## General Merchandise Wagons

Code	Description	Price per unit
C.51	BR 1/801 12T Fish Van <i>The final BR fish van diagram built 1957-60 with the BR clasp brake. Many were later used as parcels vans (SPV). Etched chassis and body with a cast resin roof.</i>	<b>Out of Stock</b>
C.53	LMS D.1892 5 Plank Open Wagon Body 'Kit' <i>Etched ends, floor and ironwork only for use with Parkside Dundas PC02A sides (not included). Suitable chassis: B.12 &amp; B.52.</i>	£10
C.53A	LMS D.1892 5 Plank Open Wagon Body 'Kit' – Steel Reinforced Ends <i>Etched ends, floor and ironwork only for use with Parkside Dundas PC02A sides (not included). For wagons where the lower end planks were replaced with steel channel. Suitable chassis: B.12 &amp; B.52.</i>	£12
C.54	BR 1/040 Wooden Ended Shocopen Wagon Body 'Kit' <i>Etched ends, floor and ironwork only for use with Parkside Dundas PC02A or PC28 sides (not included). Due to steel shortages in 1952 half a lot of BR Shocopens were built with wooden rather than steel corrugated ends. Includes tarpaulin bar kit B.92. Suitable chassis: B.11 (would also require shock absorbing spring etch B.91).</i>	£11

## Wagon Castings

### Vacuum Cylinders

F.01	18" Wagon Vacuum Cylinders and Brackets <i>Set of 3 whitemetal vacuum cylinders and etched brackets.</i>	£6
F.02	21" Wagon Vacuum Cylinders and Brackets <i>Set of 3 whitemetal vacuum cylinders and etched brackets.</i>	£6
F.02A	21" Hopper Wagon Vacuum Cylinder and Brackets <i>Set of 1 whitemetal vacuum cylinder and etched brackets for hopper wagons.</i>	£2
F.03A	Bogie Bolster C late type bolsters (diagram 1/474 & 1/477) <i>Set of four whitemetal bolsters and etched detailing parts.</i>	£6.50
F.03B	Bogie Bolster C late type bolsters (diagram 1/475) <i>Set of four whitemetal bolsters and etched detailing parts.</i>	£6.50

The difference between F.03A and F.03B lies in the centre pair of bolsters. On diagram 1/475 wagons these were fixed meaning the ends of the bolsters were slightly different. F.03A consists of four Type A bolsters and F.03B consists of 2 Type A bolsters and 2 type B bolsters.

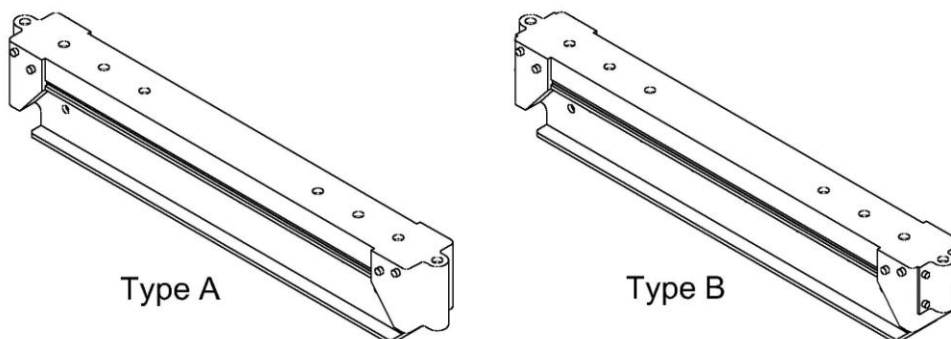

## Standard Wagon Axleboxes and Springs

<b>Various</b>	Set of four whitmetal axleboxes and springs	£3
----------------	---	----

### Notes:

Oil axleboxes come with the axlebox attached to the spring and are slotted for use with sprung underframes. **FA-FD & FM** are based on prototypes with 9" x 4½" journals and are for wagons of 12T to 16T capacity. **FN-FS** are based on prototypes with 10" x 5" journals and are for wagons of 20T to 22T capacity (heavy duty - HD). If you are using the HD axleboxes (**FN-FS**) on wagons produced by other manufacturers you will need backing plates (**B.112**) for the reinforced axlebox guides riveted to the axleguards. You do not need them for Rumney Models kits. Roller bearing axleboxes come with both a hooded and non-hooded type. These are separate from the spring and are designed to be attached to the bearing in the spring carrier on my suspension system except for the BR brake van ones where the bearing is attached to the spring.

Axleboxes types currently available:

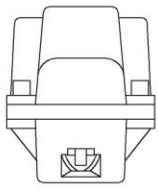
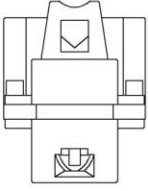
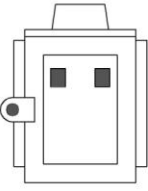
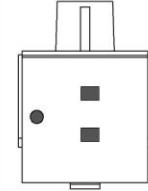
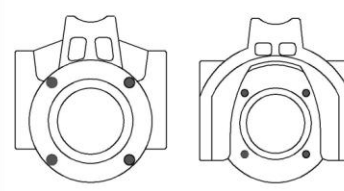
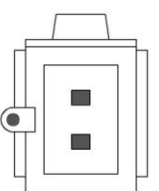
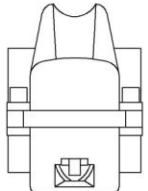
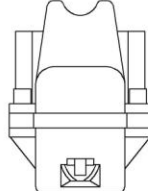
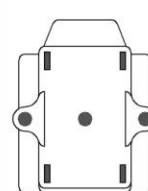
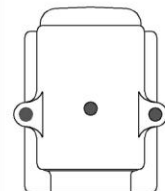
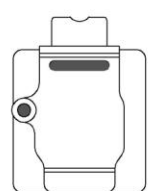
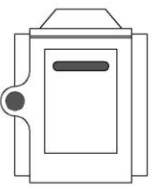
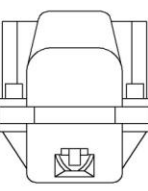
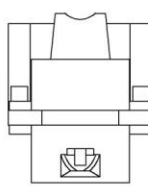
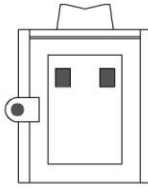
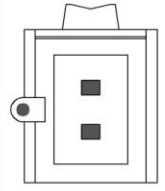
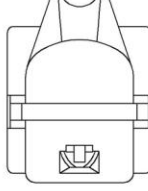
					
<b>FA</b> BR 2 Part	<b>FB</b> BR 2 Part Square	<b>FC</b> BR Welded Horizontal Lugs	<b>FD</b> BR Platefront	<b>FE</b> Roller Bearing Non-hooded & Hooded	
					
<b>FF</b> BR Welded Vertical Lugs	<b>FG</b> RCH 2 Part	<b>FH</b> LMS 2 Part	<b>FJ</b> LMS Platefront Vertical Front	<b>FK</b> LMS Platefront Sloping Front	<b>FL</b> LNER Cast
					
<b>FM</b> LNER Welded	<b>FN</b> BR 2 Part HD	<b>FO</b> BR 2 Part Square HD	<b>FP</b> BR Welded HD Horizontal Lugs	<b>FQ</b> BR Welded HD Vertical Lugs	<b>FS</b> RCH 2 Part HD

The following table shows the combinations available. The code is given by two parts. The first part is the axlebox reference and the second the spring type.

The springs are arranged by the number of leaves so **05** is a 5 leaf springs, **06** is a 6 leaf spring, etc.

**07LM** refers to the LMS 7 leaf springs with J hangers that were found on general merchandise wagons fitted with their clasp braking system (Rumney Models underframes B.51 and B.52).

**07BR** are BR 20T brake van springs with their own distinctive J hangers and are ideal for Dave Bradwell's underframes.

	<b>05</b>	<b>06</b>	<b>07LM</b>	<b>07BR</b>	<b>07</b>	<b>08</b>	<b>09</b>
<b>FA</b> - BR 2 Part	•	•	•	•			
<b>FB</b> - BR 2 Part Square	•	•	•				
<b>FC</b> - BR Welded - Horizontal Lugs	•	•	•				
<b>FD</b> - BR Platefront	•	•	•	•			
<b>FE</b> - Roller Bearings	•	•		•	•	•	•
<b>FF</b> - BR Welded - Vertical Lugs	•						
<b>FG</b> - RCH 2 Part	•	•					
<b>FH</b> - LMS 2 Part	•		•				
<b>FJ</b> - LMS Platefront - Vertical Front	•		•				
<b>FK</b> - LMS Platefront - Sloping Front	•	•	•				
<b>FL</b> - LNER Cast	•		•				
<b>FM</b> - LNER Welded	•	•		•			
<b>FN</b> - BR 2 Part HD					•		
<b>FO</b> - BR 2 Part Square HD					•		
<b>FP</b> - BR Welded HD - Horizontal Lugs					•		
<b>FQ</b> - BR Welded HD - Vertical Lugs					•		
<b>FS</b> - RCH 2 Part Cast HD					•		

## What to order

So if you want a set of BR 2 part axleboxes with 6 leaf springs then use the code **FA.06**.  
If you want a set of BR Platefront axleboxes with 7 leaf LMS springs then use the code **FD.07LM**.

If you want a set of roller bearing axleboxes and 8 leaf springs then use the code **FE.08**.  
Etc...

## Other Types of Axleboxes and Springs

### Brake Vans

<b>FN.09GW</b>	GWR Brake Van Springs and BR 2 Part HD Oil Axleboxes	£3
<b>FS.09GW</b>	GWR Brake Van Springs and RCH 2 Part HD Oil Axleboxes	£3
<b>FT.10LMST</b>	LMS Stanier Brake Van Springs Axleboxes	£3

GWR brake van springs are the later swing link type with 10" journals for diagrams AA.15 (last batch), AA.19, AA.20, AA.21, AA.23 - They will need backing plates B.112 for the reinforced axlebox guides.

### Sprung Freight Bogies

Sprung 5'6" freight bogies. Etched sideframes and bolster with cast whitemetal bolster springs and journals. Etch, spring wire and castings included. Price is for a pair of bogies.

<b>G.01</b>	BR 5'6" Plate Freight Bogie - Oil Journals <i>Standard design with oil journals.</i>	£12
<b>G.02</b>	GWR 5'6" Plate Freight Bogie - Roller Bearing Journals <i>Standard Design with roller bearings.</i>	£12
G.04	GWR 5'6" Plate Freight Bogie - Standard Standard design also found under early BR built stock.	£12
G.05	GWR 5'6" Plate Freight Bogie - Heavy Duty Heavy duty design with distinctive scallop shell journals.	£12

## BR 5' 6" Plate Freight Bogies

### G.01 Oil Bearings

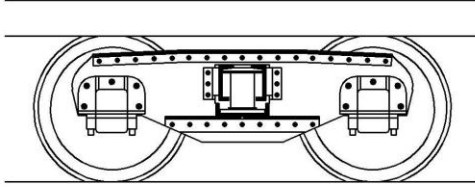

### G.02 Roller Bearings

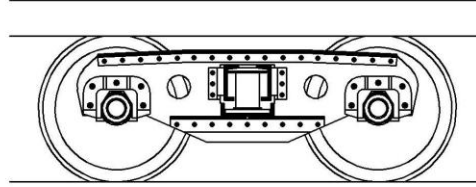

## GWR 5' 6" Plate Freight Bogies

### G.04 Standard

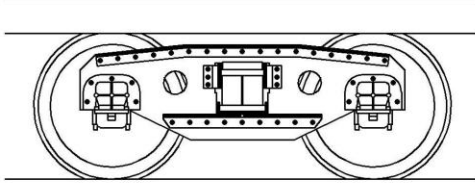

### G.05 Heavy Duty

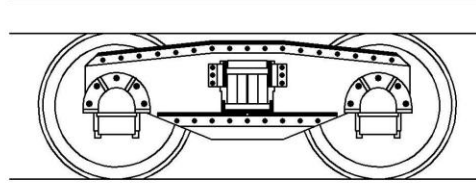

### Fully Sprung Diesel Bogies

An aid to producing a fully sprung diesel locomotive. P4 only unless indicated. Includes etch, spring wire and custom hornblocks. Each kit is sufficient for one locomotive.

<b>D.01</b>	English Electric Bogies <i>For classes 37, 50, Deltic and DP2.</i>	Withdrawn
<b>D.02</b>	Peak Bogies (including pony trucks) <i>For classes 40, 44, 45 &amp; 46.</i>	Withdrawn
D.03	Peak Pony Trucks <i>Pair of pony trucks to fit the Bachmann Peak chassis.</i>	£6
D.03A	Peak Pony Trucks - <u>EM Gauge</u> <i>Pair of pony trucks to fit the Bachmann Peak chassis.</i>	£6
<b>D.05</b>	Brush Type 4 Bogies <i>For classes 47 and 57.</i>	Withdrawn
<b>D.06</b>	Warship Bogies <i>For the Bachmann Swindon class 42 model.</i>	Withdrawn
X.02	Class 30/31 bogies <i>For the all wheel drive Hornby model.</i>	£33

### Fully Sprung Single Bolster Coach Bogie Subframes

Coach bogie subframes that work like the real thing. Etch, spring wire and bearing pins included. EM/P4 only. Price is for a pair of bogies.

E.01	8'6" BR Mk1 BR1 Coach Bogies	£11
E.02	8'6" BR Mk1 Commonwealth Coach Bogies	£11
E.04	9' GWR Pressed Steel Coach Bogies	£11
E.05	9' GWR Heavy duty Coach Bogies	£11
E.06	7' GWR Coach Bogies	£11

### Steam Loco Chassis

Code	Description	Price per unit
X.01	GER/LNER/BR F4/5/6 2-4-2T <i>For EM and P4 only. A modern fold up nickel silver chassis to suit the Alan Gibson kit. Features built in CSB suspension along with brakegear, cosmetic driving wheel springs, ashpan detailing, guard irons, balance weights and 'phony trucks' to enable the loco to traverse curves down to 1m radius.</i>	£32
X.04	MR/LMS/BR 1P 0-4-4T <i>For EM, P4 and OO. A modern sprung chassis to suit the Craftsman LMS 1P kit. Features sprung driving wheels, a sprung bogie, full brakegear, dummy inside motion, 3D printed details and a removable keeper plate with cosmetic driving wheel springs.</i>	£38

### Miscellaneous

X.03	CSB Carrier Tags for Brassmasters Hornblocks Two sets of 6 CSB carrier tags with 2 different hole sizes for use with Brassmasters hornblocks.	£1.50
------	--	-------

### 7mm Scale

The Milk Tank detailing and coach bogies are redrawn and resized from the 4mm scale artwork and etched on 0.012" brass. The Milk Tank plates were drawn up from my original artwork not the 4mm version. In short these are not just straight enlargements.

### Milk Tank Detailing

OA.07	United Dairies SR/GWR Platforms <i>The distinctive platforms fitted to some United Dairies milk tanks.</i>	£12
OA.08	SR/GWR Platform construction jig <i>Needed to build A.07.</i>	£10

### Milk Tank Plates

OA.21A	United Dairies Ltd Milk Tank Plates - Type A <i>Company plates for United Dairies milk tanks.</i>	£3.50
OA.21B	United Dairies Ltd Milk Tank Plates - Type B <i>Company plates for United Dairies milk tanks.</i>	£3.50
OA.22	Unigate Creameries Milk Tank Plates <i>Company/number plates for Unigate milk tanks.</i>	£3.50
OA.23	Express Dairy Milk Tank Plates <i>Company/number plates for Express Dairy milk tanks.</i>	£3.50

UNITED DAIRIES ( W ) LTD

- United Dairies Type A

UNITED DAIRIES ( W ) LTD

- United Dairies Type B

UNIGATE CREAMERIES LTD 2536

- Unigate Creameries

EXPRESS DAIRY



- Express Dairy

The 7mm scale version follows the same numbering pattern as the 4mm ones. The United Dairies plates were common in the 1950s but could also be seen through to the 1970s. Type A was much more common than type B. Unigate plates would be found on wagons post 1959. They have the wagon number on the plate and I have done plates for most Unigate diagrams. Please enquire first if you are after plates for specific diagrams. If you aren't worried about diagrams then please say so when ordering. Express Dairy plates include both the company plate and the distinctive round number plate that was attached to the baulks at the tank ends. The numbers were Express Dairy's own fleet numbers and were generally grouped according to who built the milk tank. If you want something specific then please inquire or else you will get a random number. Etched on 0.1mm stainless steel and supplied in pairs and painted.

### Wagon Detailing

Code	Description	Price per unit
OB.92	Tarpaulin Bar Detailing <i>For BR/LMS open wagons with corrugated steel ends. Both early and late types are included. Sufficient parts for two wagons. Wire for the bar is required.</i>	£7
OB.109	Grampus Detailing <i>A pair of detailed baskets, door springs and end steps.</i>	£9
OB.110	RCH 12' Lifting Link Brakegear Detailing <i>A general purpose detailing fret. Includes 12' brakegear, vees, brake levers, lifting links &amp; two types of lever guards. Also 21T hopper door handles &amp; end steps and mineral wagon door springs.</i>	£12
OB.111	21T Vacuum Braked Hopper Detailing <i>All the bits specific to the vacuum brakegear on 21T hoppers. Includes vacuum cylinder brackets, brake links and lamp irons.</i>	£2

### Sprung Coach bogies

Available to order only.

OE.02	8'6" BR Mk1 Commonwealth Coach Bogies <i>A fully sprung single bolster coach bogie in 7mm scale. Includes provision for 7mm finescale and Scale 7 wheelsets.</i>	£33
-------	---	-----

## S Scale

Redrawn and resized from the 4mm scale artwork and etched on 0.012" brass. These are not just straight enlargements. They are available to order only.

Code	Description	Price per unit
SA.01	GWR Standard 20'6" Milk Tank Components <i>A sheet of etches covering almost everything I have done for standard GWR milk tanks but on one sheet in S Scale. Includes a fully sprung chassis, solebars, headstocks, both D/C and lever brakegear, ladders and partial platforms, walkways and tank straps. The only appropriate thing that I've done that isn't included is the United Dairies platforms. If anyone wants them then ask.</i>	£30
SB.13	BR 16'6" x 9' Morton Brake Chassis – 16T Welded Mineral For the standard welded body, Morton brake 16T mineral wagons. Tailored to suit the Alan Gibson Whitemetal body.	£12
SB.16	BR 16'6" x 9' Independent Brake Chassis – 16T Welded Mineral For the standard welded body, Independent brake 16T mineral wagons. Tailored to suit the Alan Gibson Whitemetal body.	£14
SB.32	RCH 17'6" x 9' Morton Brake Chassis For LMS & GWR vans, Conflats, opens, etc.	£18
SB.51	17'6" x 10' LMS Clasp Brake Wagon Chassis For Vans, Opens, Shocopens, Conflats, etc. Specification is as per the 4mm chassis and includes both RCH and BR type axleguards.	£20

